



# CONTOUR CONSOLE

FORD F-150 SSV/POLICE RESPONDER 2021+  
FORD F-250 2023+

Installation Instructions

425-6524



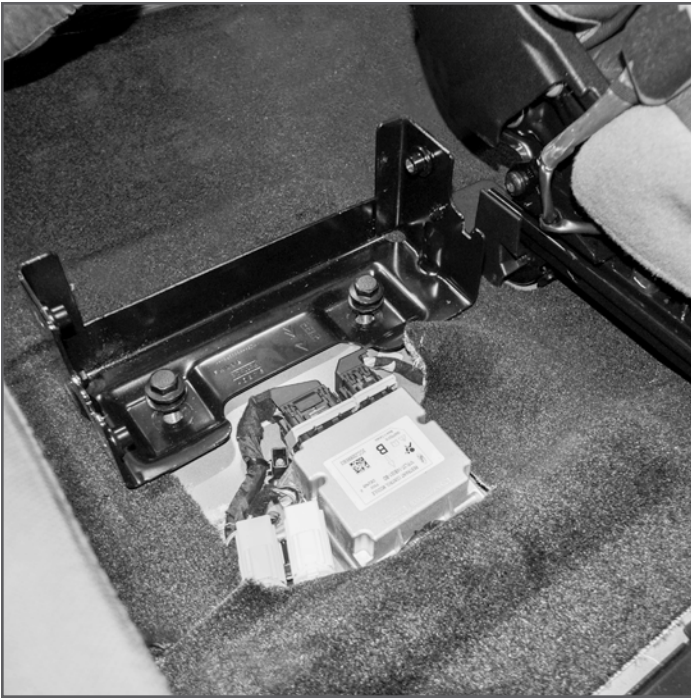

1. Remove (2) OEM mounting brackets.

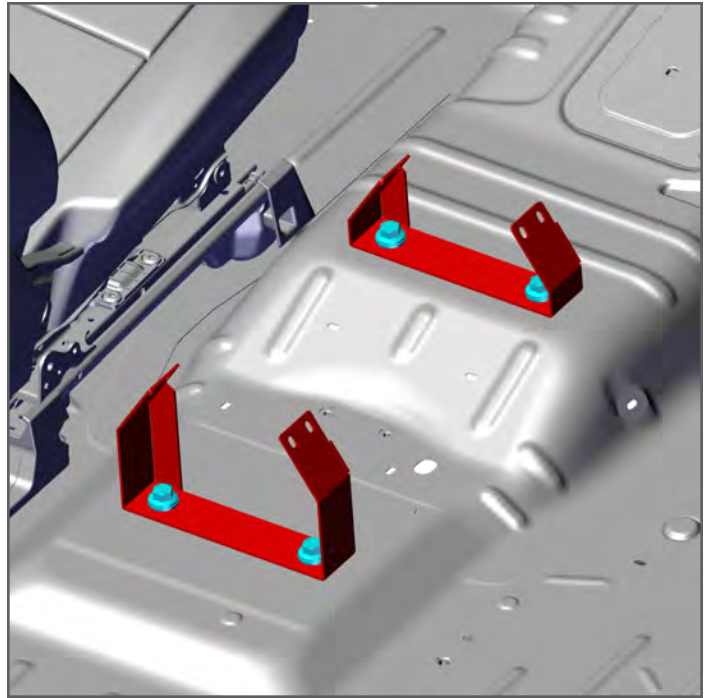

2. Place front and rear Floor Plate Brackets over hole locations. Secure with provided bolts or OEM hardware.

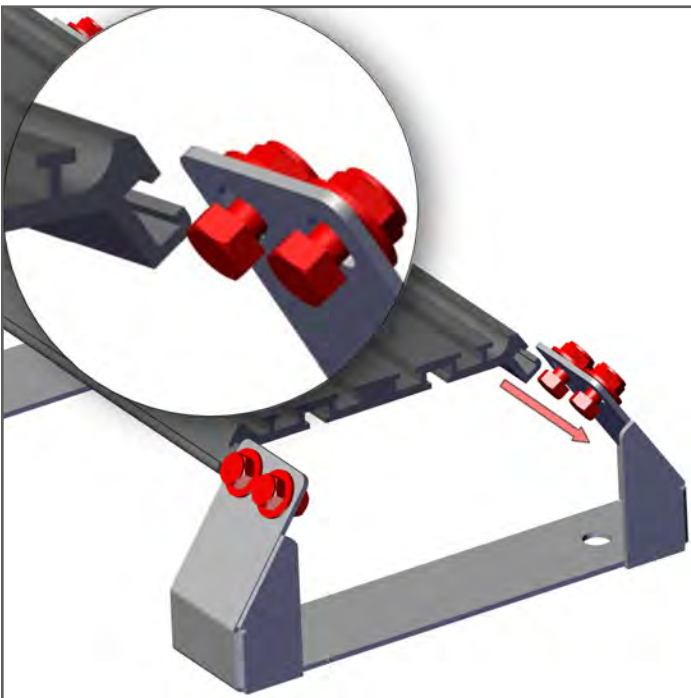

3. Lightly secure (8) of the 5/16-18 bolts, washers and nuts to the Floor Plate Brackets. Slide the Floor Plate in from the rear, aligning the bolts with the sides grooves on the Floor Plate sides.

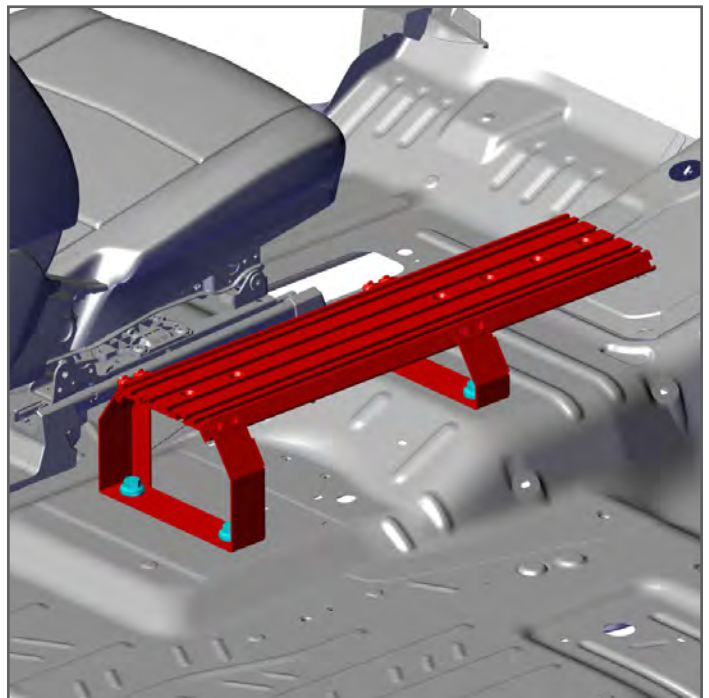

4. Place the Floor Plate in desired location by sliding forward and back. Secure by tightening the 5/16 nuts.



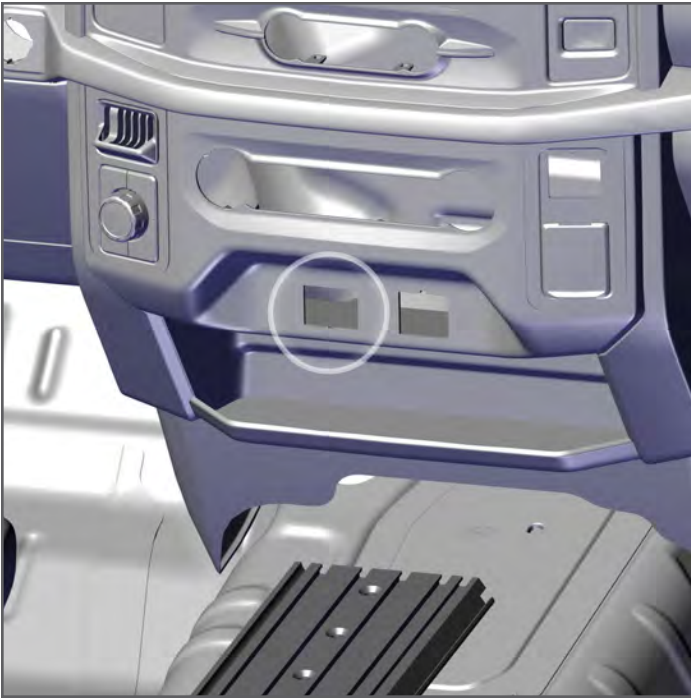

5. Using a trim tool, pop out and relocate the USB from the vehicles dash to the top of the Contour Console.

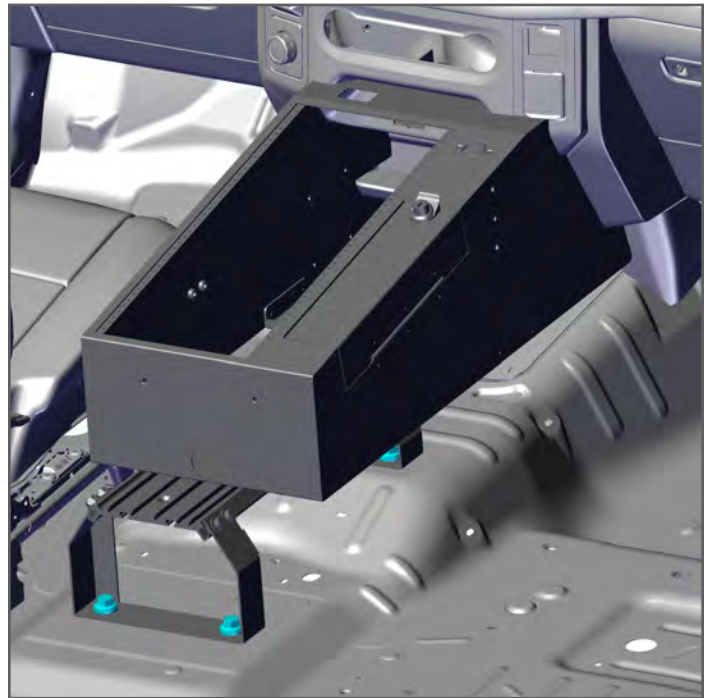
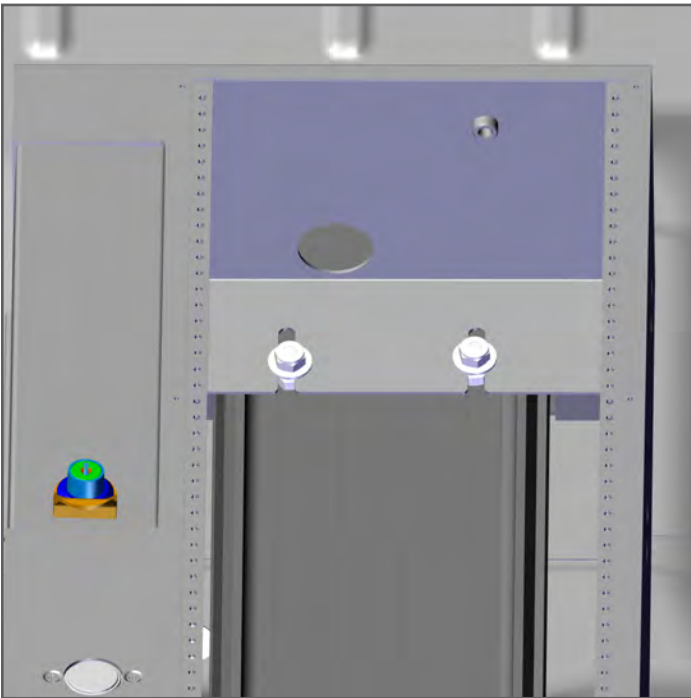

6. Place Console on Floor Plate making sure the front and sides are up against the dash and secure in place with provided (4) 5/16-18 bolts, washers and nuts. Plug in the OEM USB Cable(s).

If you have questions or need further assistance please call Technical Support: 1.877.455.6886



**209 W. EASY ST., ROGERS, AR 72756 • JOTTOPUBLICSAFETY.COM • 3/24**

Jotto Desk™ is a patented product and Registered Trademark of Assembled Products™ Corporation.  
Specifications subject to change without notice.