



SINGLE CELL LITE

CHEVROLET SILVERADO SSV 2019-2022

Installation Instructions

475-1380



Not Compatible with OEM Rear Underseat Storage Option

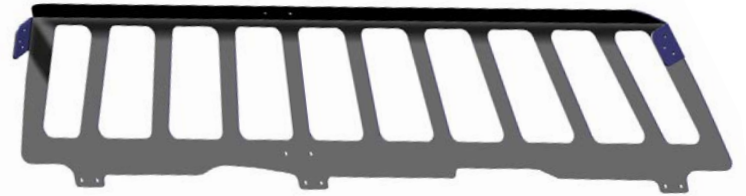
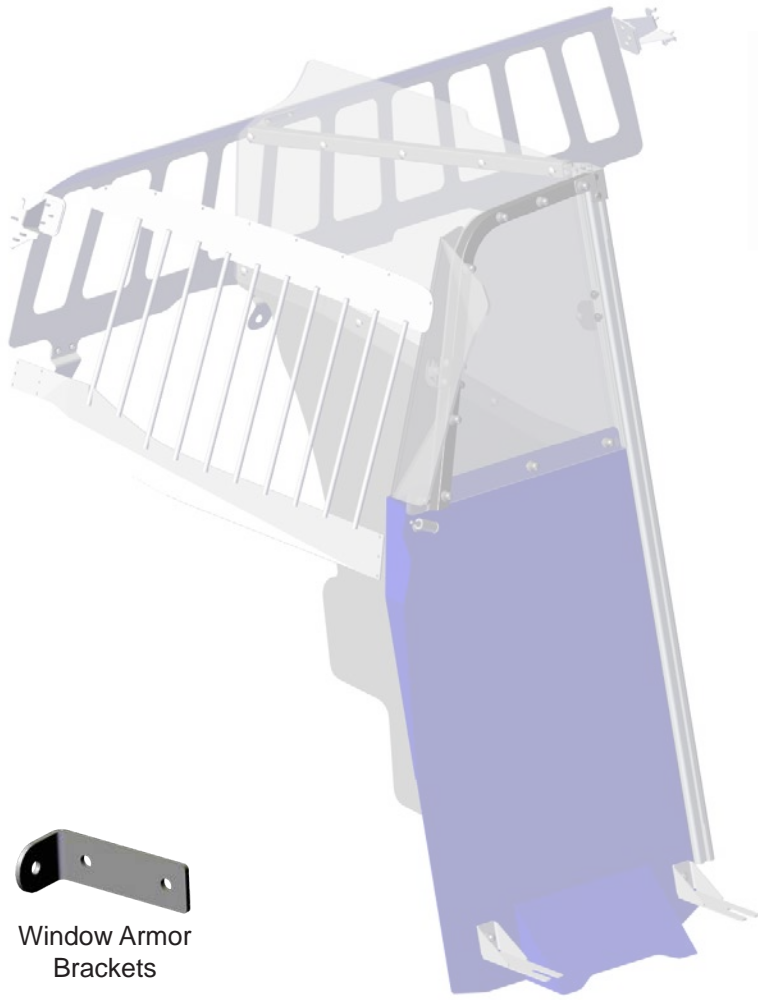

Rear Window Armor



Upper Poly Wing

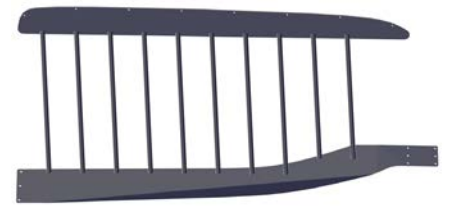

P/S Door Window Armor



Window Armor Brackets



B Pillar Bracket



Inner Foot Mount Brackets



D/S Side Mount Bracket



P/S Side Mount Bracket



Lower Mount Brackets



Assembled Front Divider

Upper Poly Center Divider

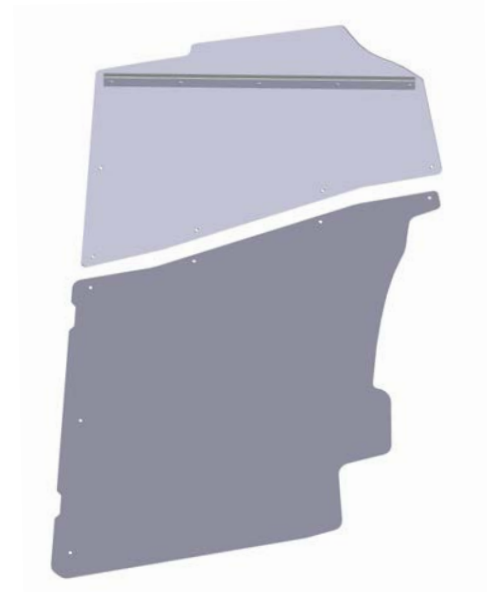

Lower Steel Center Divider

*Window Armor Install

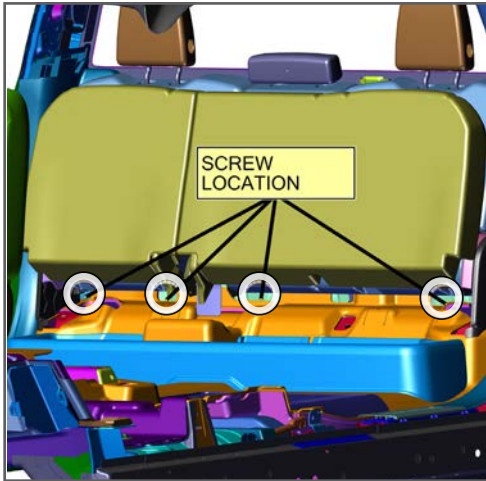

1. Lift lower rear seat cushions to access and remove (4) 10 mm bolts located on the lower section of the backseat rest. Fold seat back down.

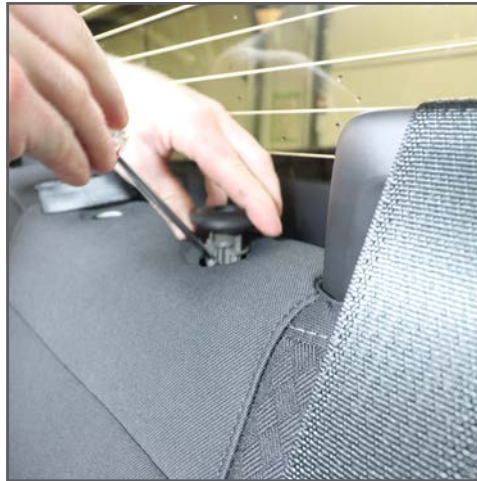

2. Remove head rest and (6) plastic head rest socket with a flat head screwdriver securing the seat to the back of the vehicle.

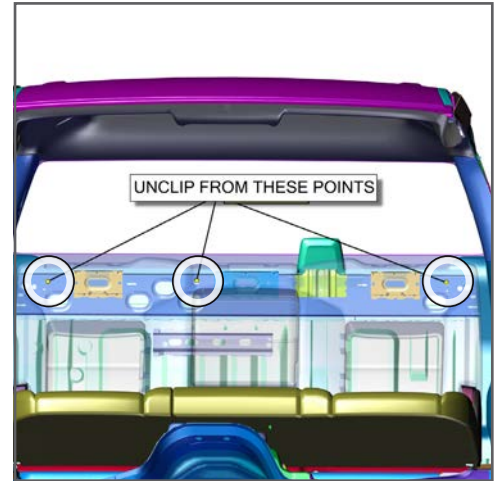

3. With a 90-degree angle pick, lift each locking tab located by the tie down straps on the rear seat. Once removed, shift entire rear seat forward.



(Close up example of using the angle pick to lift the three locking tabs from previous step.)

Angle Pick



4. Remove "C" pillar upper OEM trim. With a flat trim tool, remove seat belt socket guide (1) then the trim (2).



5. Remove the 7mm screw attaching trim to the vehicle via nylon strap.

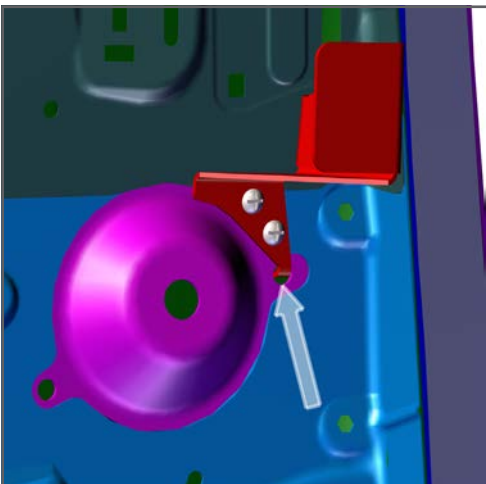

6. Attach the "P/S Armor Upper BKT" by inserting locating tab into place and secure with provide hardware.

REPEAT FOR OTHER SIDE.



7. Replace OEM "C" Pillar Trim on top of P/S Side Armor Upper Brackets.

REPEAT FOR OTHER SIDE.

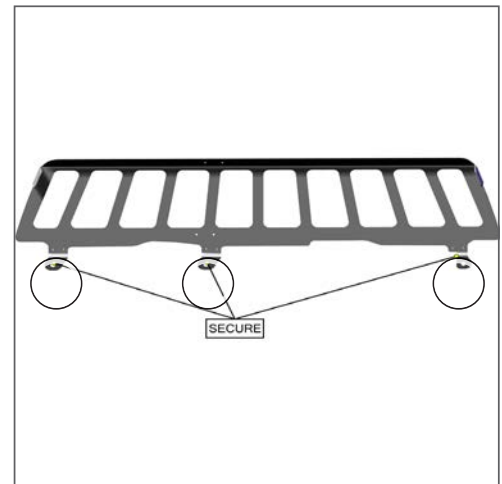

8. Loosely attach (2) P/S Lower Mount Brackets and (1) D/S Lower Mount Bracket to Rear Window Armor with provided (6) lock washers and button screws.

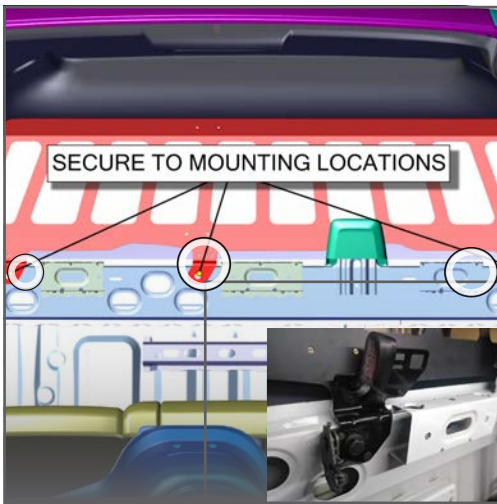

- Remove (3) 18 mm bolts attaching the tie down strap locations. Insert Window Armor with Brackets (behind the rear seat locking mechanism).

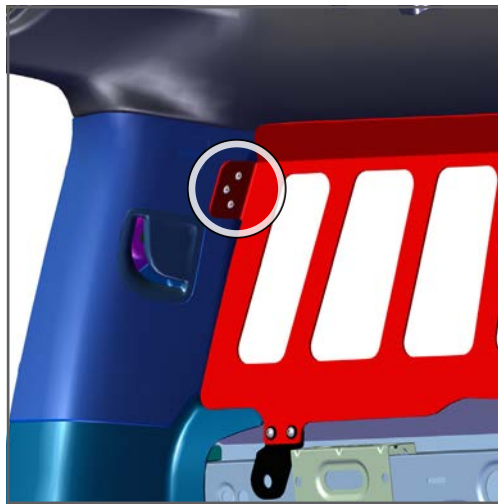

- Pull the Window Armor forward away from the glass and secure to the DS/PS Side Mount Brackets with (6) self-tapping screws.



- Once Window is in position, tighten all hardware.

REINSTALL REAR SEAT



- Align P/S Door Window Armor into position following contour of door frame. Secure Window Armor into place using provided tek-screws.

***End of Window Armor Install**

*Single Cell Install

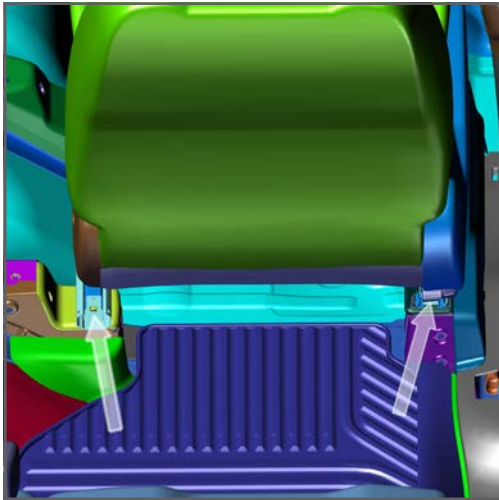

1. Slide P/S front seat completely forward. Loosen the rear T-50 OEM seat bolts.

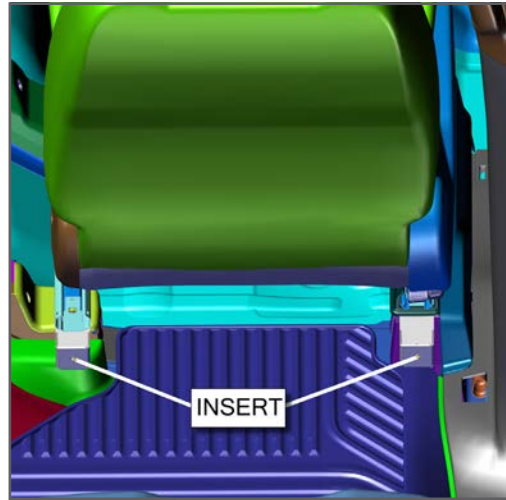

2. Push seat up slightly to slide the Foot Mount Brackets under seat rails, between rail and carpet. Leave bolts loose at this time

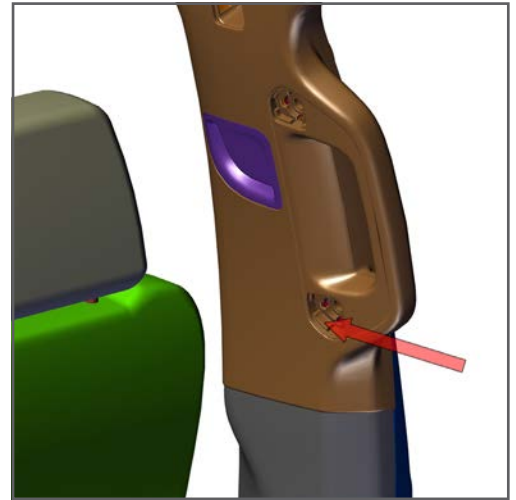

3. Remove cover from lower sections of handle located on B pillar, and then remove OEM hardware with 10 mm socket.

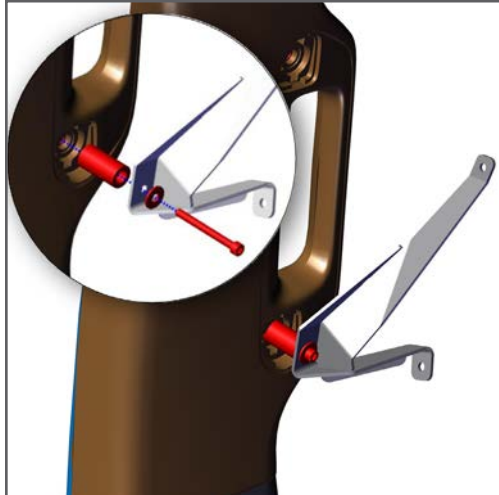

4. Loosely attach spacer and B Pillar Bracket into OEM lower handle location with provided hardware.

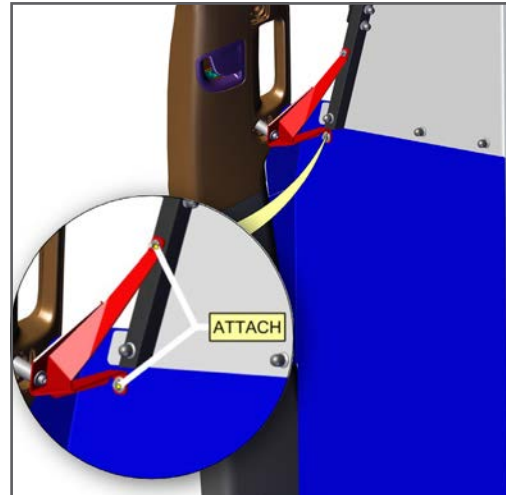

5. Install Assembled Front Divider into vehicle and loosely attach to B Pillar Bracket.

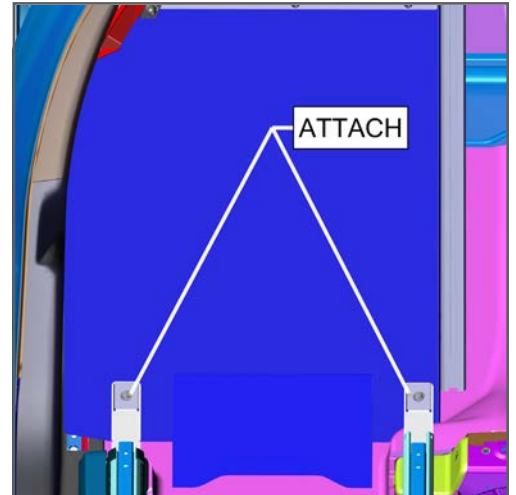

6. Adjust the Foot Mount Brackets to the lower Assembled Front Divider. This will require a little twisting to get into proper position. Attach with provided carriage bolts and flange nuts.

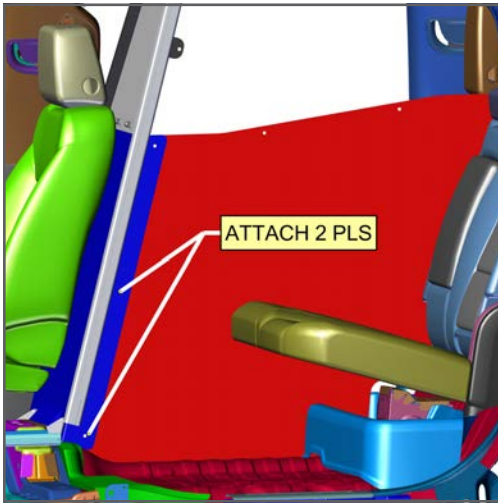

7. Loosely secure Lower Steel Center Divider onto Assembled Front Divider using provided carriage bolts and flange nuts.

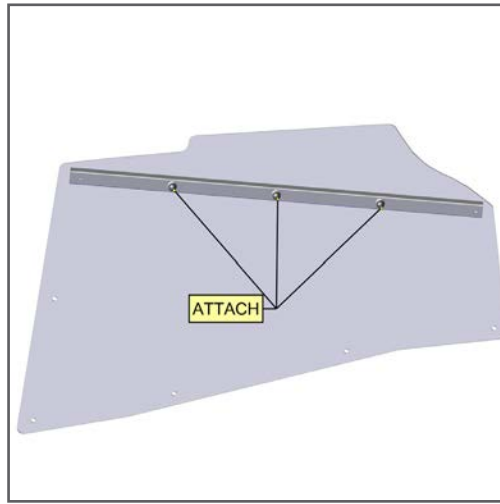

8. Attach Stiffener Tube to D/S of Upper Poly Center Divider.

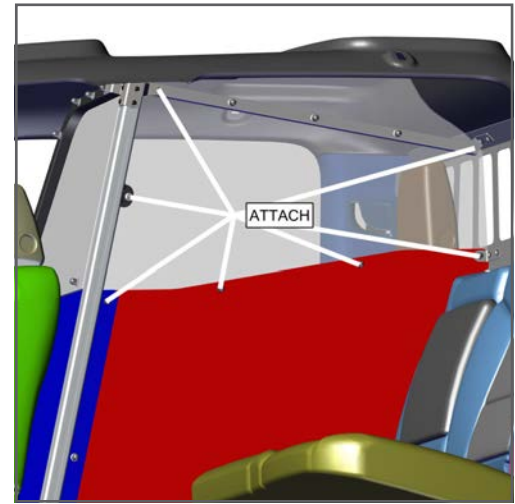

9. Attach Upper Poly Center Divider to Lower Steel Center Divider, Assembled Front Divider and Rear Window Armor with carriage bolts and flange nuts.

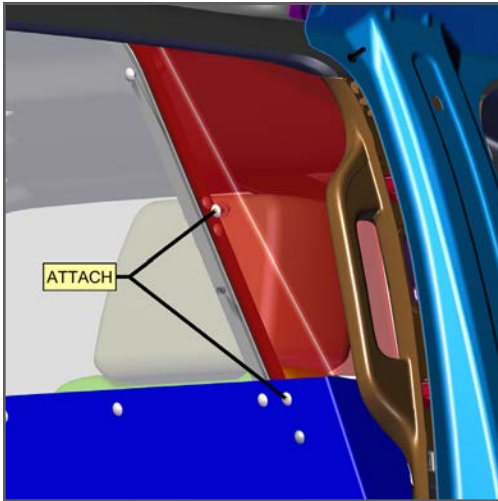

10. Install Upper Poly Wing from front of vehicle using carriage bolts and flange nuts.

If you have questions or need further assistance please call Technical Support: 1.877.455.6886



209 W. EASY ST., ROGERS, AR 72756 • JOTTOPUBLICSAFETY.COM • 5/23

Jotto Desk™ is a patented product and Registered Trademark of Assembled Products™ Corporation.
Specifications subject to change without notice.