

1. Remove the (2) 18 mm nuts and (2) 18 mm bolts located at the base of the rear seat.
2. Remove the seat, by tilting the back rest down and locating the (2) cable hoops on the outer most part of the seat. Pull the top seat hoop first, then the bottom. This will release the seat from its position.
3. Cut and remove the carpet in front of the Cargo Storage Boxes.

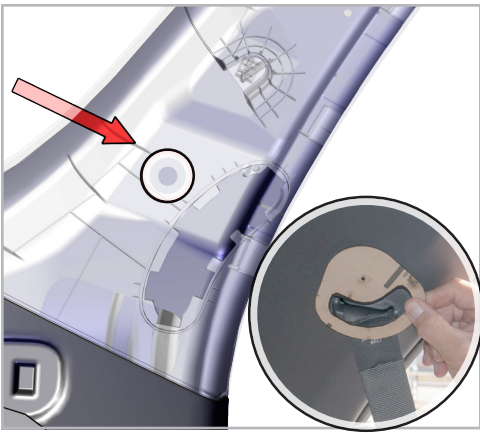

4. Pop loose the seatbelt trim, then place the provided Drill Template on the C-pillar trim, align the arch, and mark a drill hole.
5. Drill out the hole to 1/2" to accommodate C-Pillar Spacer.
6. Remove the seat belt and OEM hardware. Then remove the seatbelt trim from the seatbelt for use later.

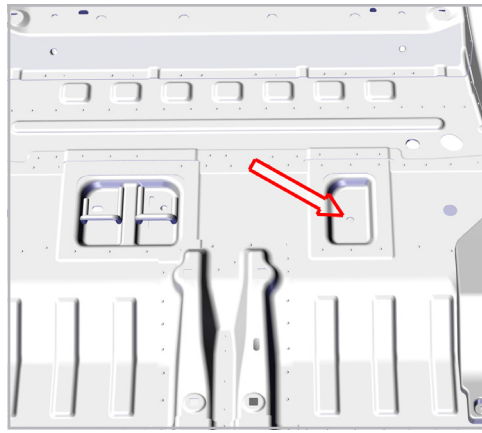

7. Prep the floor for the Frame Assembly by installing the provided 1/2-13 Rivet Nut. **NOTE:** See attached AVK Install Instructions on the last page.

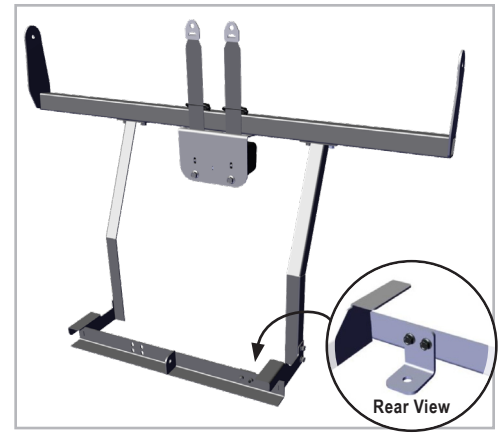

8. Pre-assemble the Seat System Frame by attaching the PS/DS Leg Assembly to the Lower Combination Bracket and "attaching loosely" to the Top Bar Assembly with provided (8) 3/16-16 x 3/4 Flanged Hex Head Cap Screw.
9. Attach the Floor Anchor Bracket together with (2) 5/16-18 x 3/4 Flanged Hex Head Cap Screw.

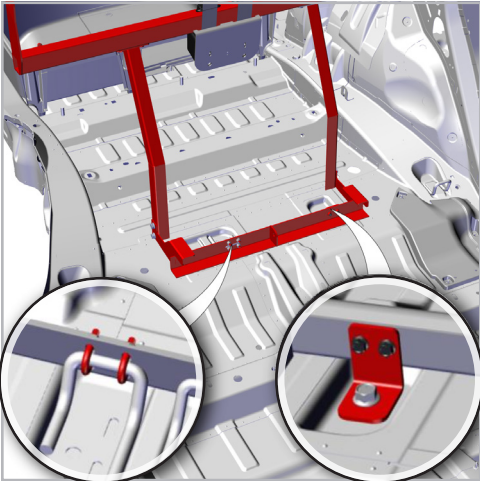

10. Insert the Frame Assembly into the vehicle by securing the Anchor Bracket to the pre-installed Rivet Nut with provided 1/2-13 x 1-1/2 Flanged Hex Head Cap Screw.
11. Attach the other side to the bottom set latch bar with provided (2) 1/2-20 x 9/16" U-Bolt and 1/2-20 Nylock Nut. **NOTE:** Some Trimming will be required on the storage boxes to fit the PS/DS Legs correctly.

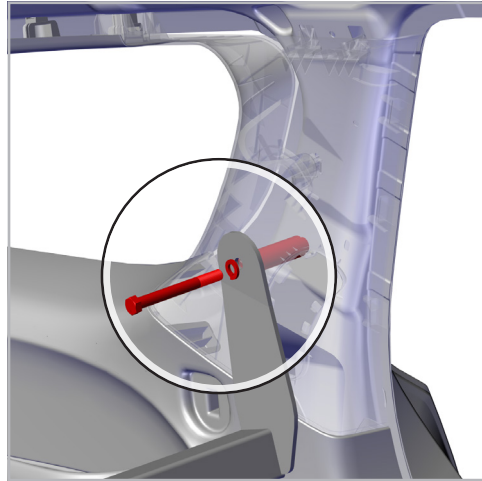

12. Attach the sides of the Top Bar Assembly to the pre-drilled holes in the C-pillar trim.
13. Insert the provided C-Pillar Spacer through the pre-drilled hole and secure in place with 7/16-20 x 4" LG Hex Head Cap Screw and 7/16 Split Lock Washer.



14. Install Hip-Side Tongue Belt using previously removed OEM nuts/bolts. **NOTE:** Roll up seat belts and place into the seatbelt cavity behind C-pillar trim.
15. Attach previously removed seatbelt trim back onto C-pillar.

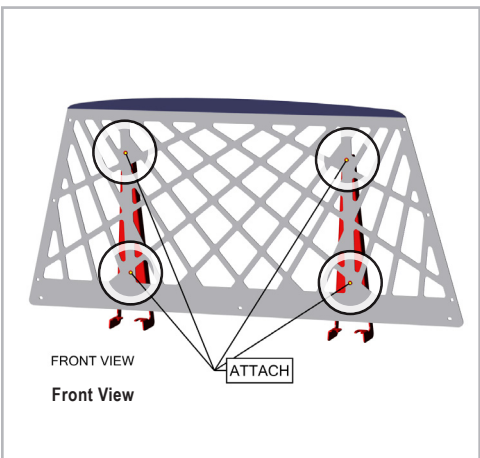

16. Attach the Cargo Barrier Brackets to the Cargo Barrier with provided (4) 1/4-20 Socket Head Cap Screws.

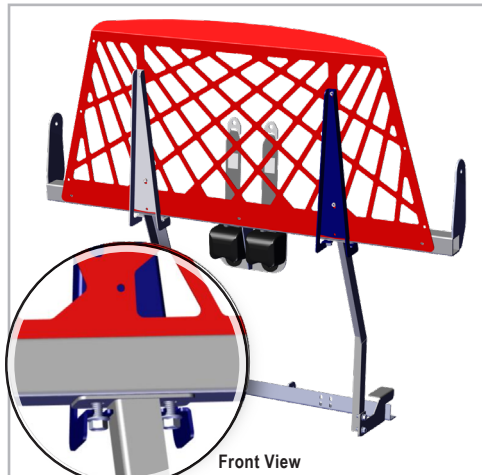

17. Attach the Cargo Barrier Brackets to the back side of the Top Bar Assembly.
18. Align the slots of the Cargo Barrier Brackets to the "previously loosened" bolts of the Top Bar Assembly. Fully secure all hardware this time.

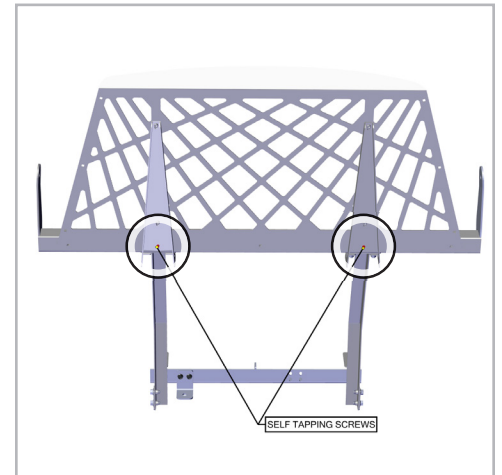

19. Secure the DS/PS Side Wings to rear of the Cargo Barrier with provided (6) 1/4-20 X 1/2 Carriage Bolt and 1/4-20 Flange and Nut Covers on the cargo side.

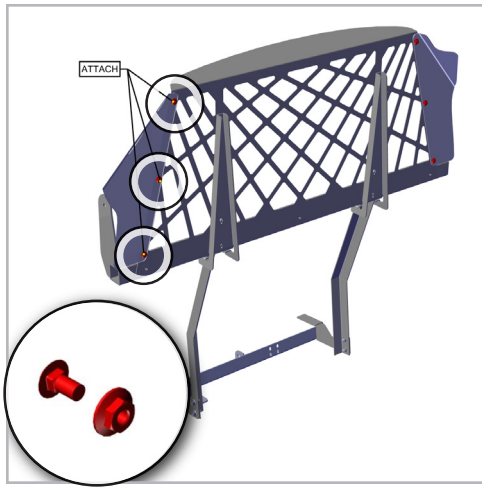

20. Secure the DS/PS Side Wings to rear of the Cargo Barrier with provided (6) ¼-20 x ½ Carriage Bolt and ¼-20 Flange Nuts and Nut Covers.



21. Attach Seat Trim Seal on locations shown.
22. Place Seat into vehicle and position seat flange onto Top Bar Assembly.



23. Fasten down Seat to the Top Bar Assembly with (4) #10 x ¾ Pan Self Drilling
NOTE: Screw locations marked in picture.

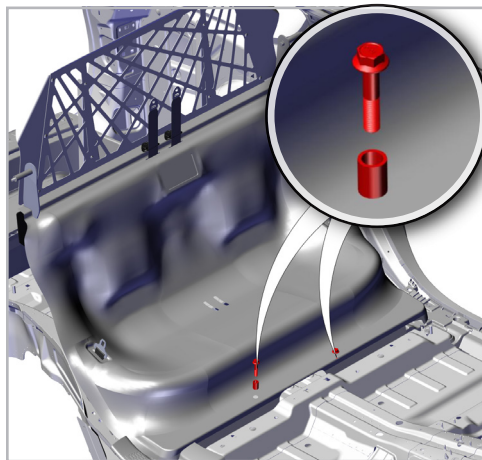

24. Secure the front lip of the Seat to the floor with provided (2) 5/8 x 1" spacer under the seat flange and M12 x 50 Hex Bolt from the top.



25. Place the Tooth C-Retainer on webbing on outboard seatbelt and outboard slot so that it pinches webbing and closes gap around webbing.

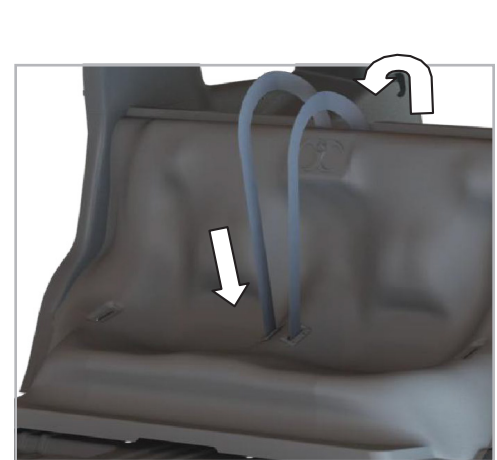

27. Attach the Red Ring Buckle to seatbelts.
28. Route the seatbelts into the center slots of the ABS seat.

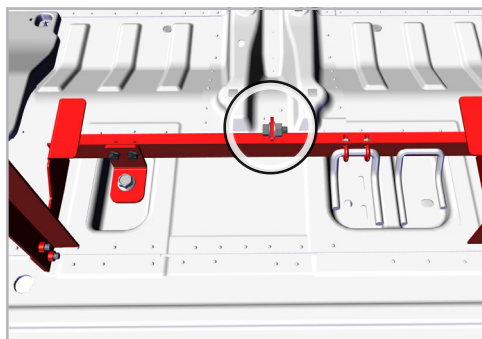

29. From the cargo compartment of the vehicle, attach the retractable belt to the center anchor point located on the Lower Combination Bracket.



30. Install (2) Belt Slot Covers around retractor webbing using built in cutout in Belt Slot Covers.
31. Ensure belt installation cutouts in Belt Slot Covers face each other and toward center of vehicle.
32. Using (14) #6 x .625 sheet metal screws secure Seat slot Covers to seat.



33. Attach Storage Tongue to Seat Belt Buckle to best determine a mounting location for the (2) Storage Tongues.
NOTE: Be sure to install the Storage Tongues low enough in the vehicle to avoid head injury during prisoner entry and exit.
34. Secure with (4) #10 x ¾ Square Drive Screws.

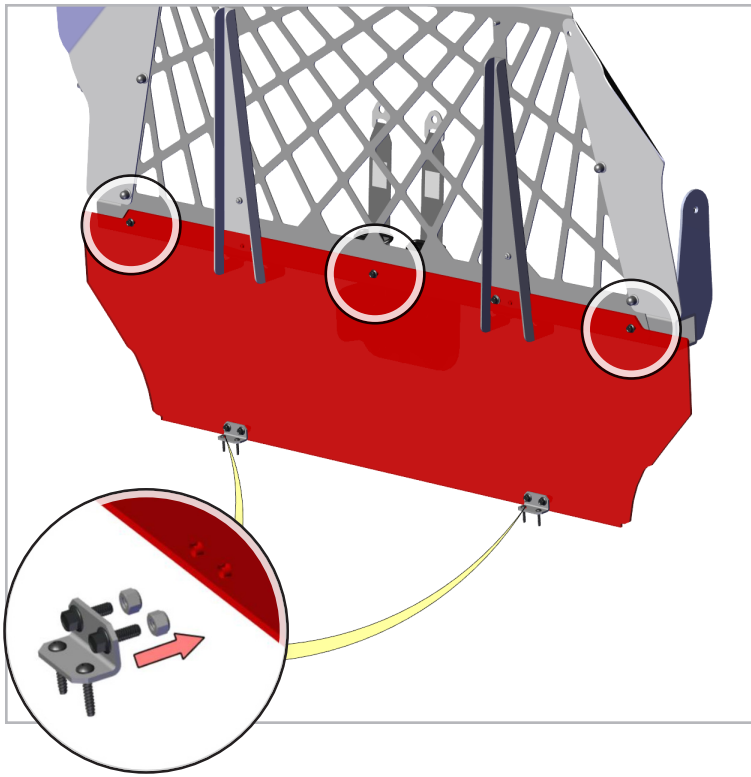

NOTE: TRIM CARGO COVER TO FIT AROUND CARGO BARRIER VERTICAL SUPPORTS. DIAGRAM ON LAST PAGE.

35. Attach the Angle Bracket Clips to the Cargo Cover with provided (4) ¼-20 Flanged Hex Head Cap Screw and ¼-20 Nylock Nuts.
36. Secure the Cargo Cover onto the Top Bar with (3) ¼-20 Flanged Hex Head Cap Screws.
37. Finish by attaching the Angle Bracket Clips to the storage box with #10 x 1 Torx Plastite Screw.

Please Note: if you have purchased the Poly Cover for Seat Replacement System (475-1598), it installs on the prisoner side of the Secure Grid Upper Barrier.

AVK Fastener Installation Instructions

AVK Installation video can be viewed at:
<http://jottopublicsafety.gojotto.com/additional-categories/downloads.html>



1. Place long bolt through the flange nut and hand thread bolt into the AVK Fastener.



2. Place into drilled hole.

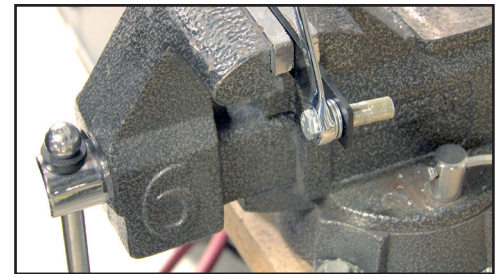

3. Use box end wrench to secure the flange nut.



4. Apply pressure on the flange nut, pressing AVK Fastener into hole.
5. Using an air wrench, tighten the bolt.



6. This will allow the AVK Fastener to secure onto the backside of the metal.
7. Return to Step 8 of the Replacement Bio Seat System Installation Instructions.

If you have questions or need further assistance please call Technical Support: 1.877.455.6886



209 W. EASY ST., ROGERS, AR 72756 • JOTTOPUBLICSAFETY.COM • 8/23

Jotto Desk™ is a patented product and Registered Trademark of Assembled Products™ Corporation.
 Specifications subject to change without notice.

