



ABS DOOR PANELS

2021+ CHEVY TAHOE

Installation Instructions

475-1980

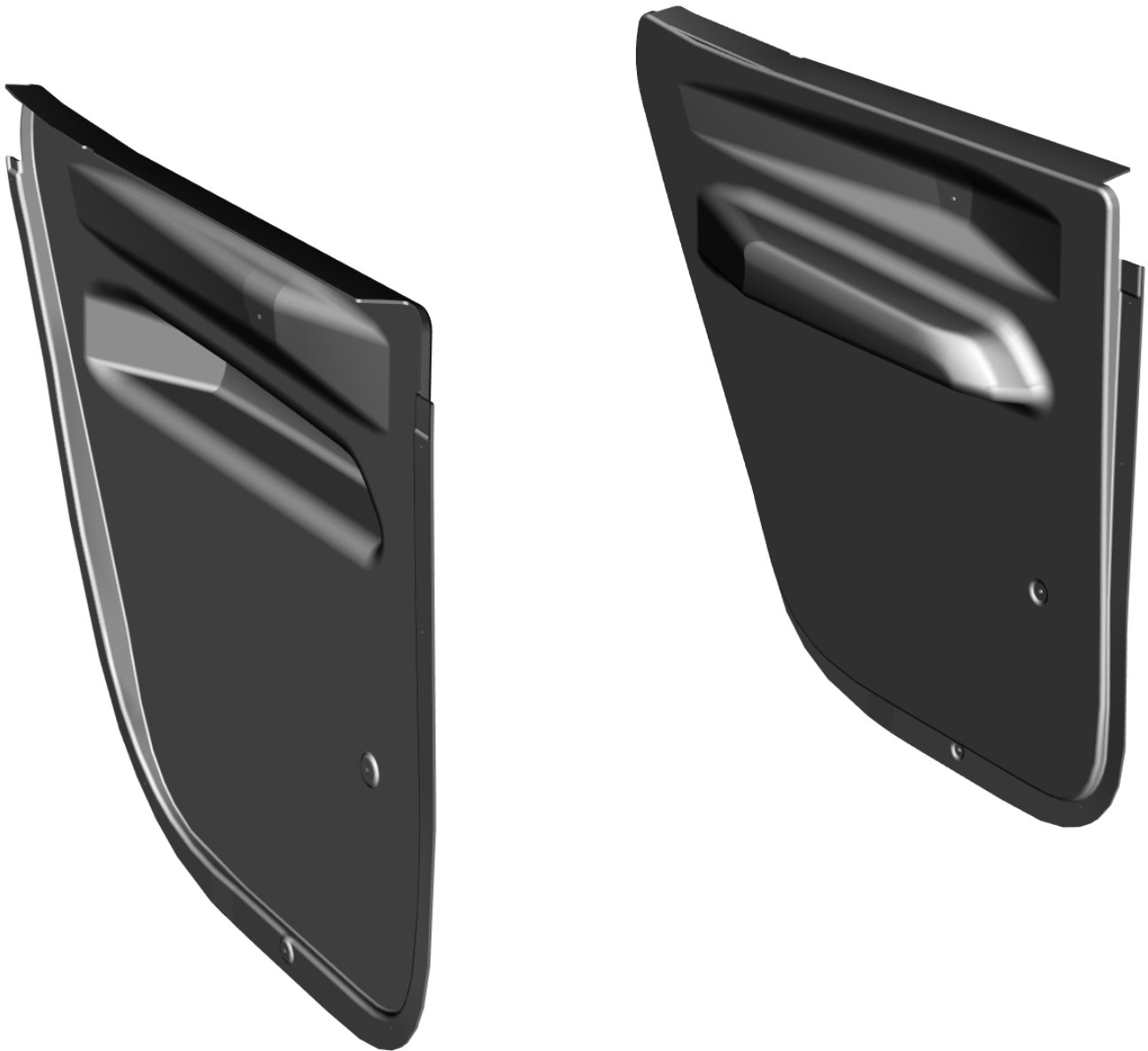

1. Use a small screwdriver to pry plastic covers from inside of door handle and armrest area to expose 7 mm screws. Remove (4) 7 mm screws. 1 from door handle, 2 from armrest and 1 from bottom middle of OEM door panel.

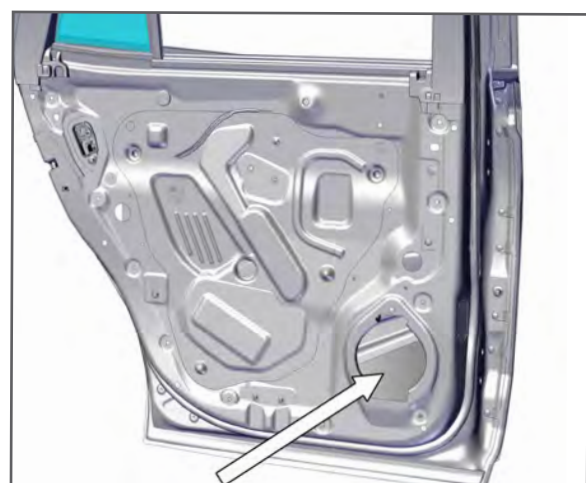
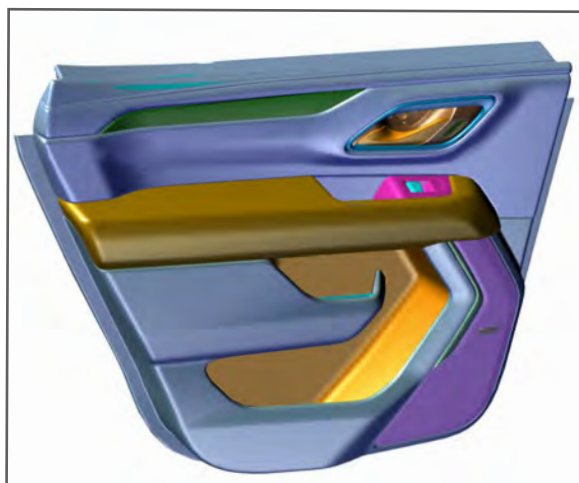
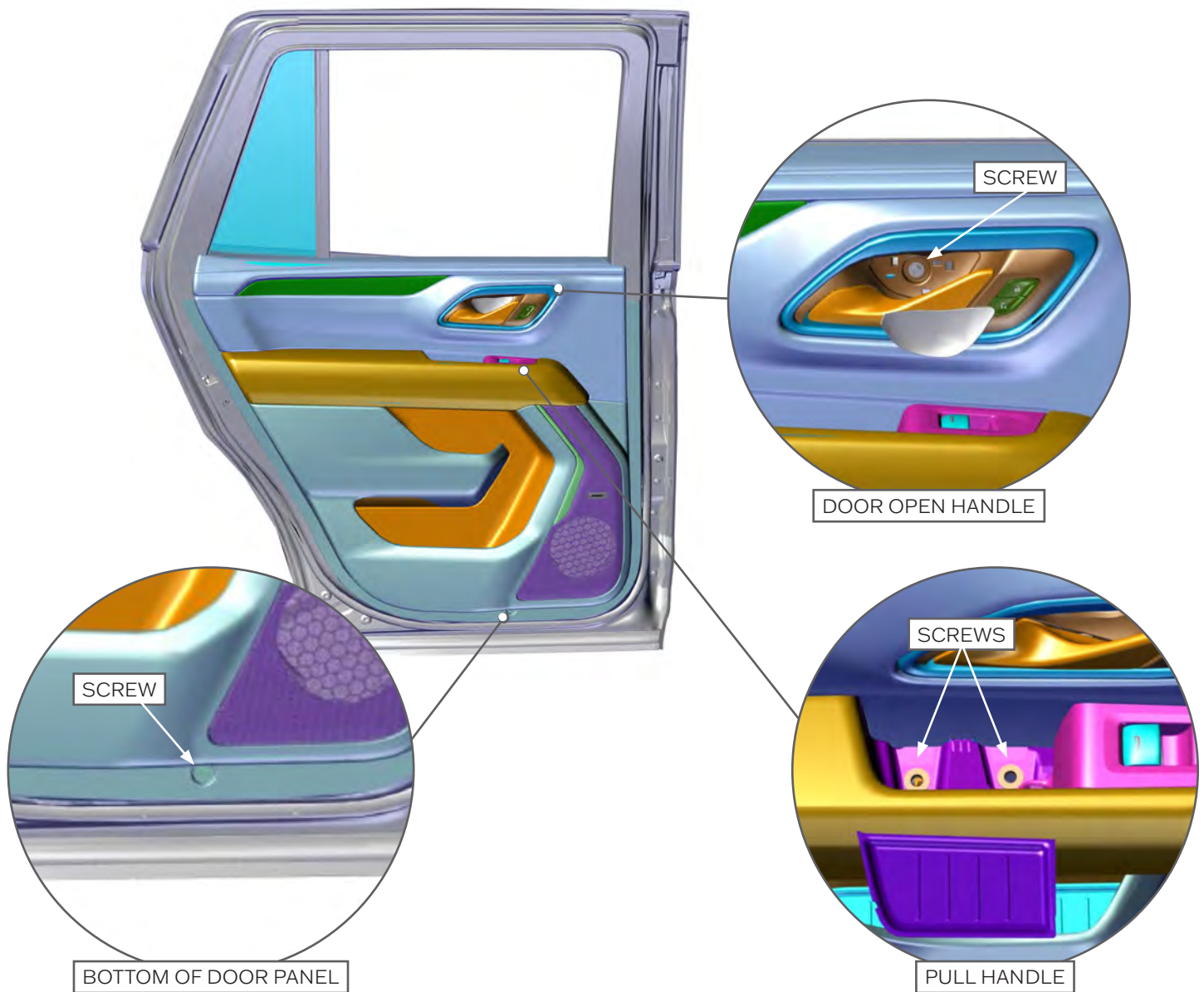

2. Carefully pry OEM door away from door panel frame. Be careful to hold onto OEM panel.
3. While still holding onto OEM door panel, begin to disconnect wiring harnesses and door latch cable. Set OEM door panel aside.
4. Detach speaker by removing (1) 7 mm screw and then disconnecting wiring harness. Set speaker aside.

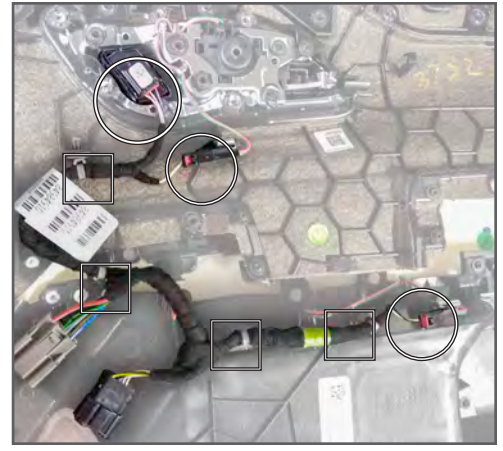

5. **IMPORTANT:** Remove window switch from front side of the door panel by removing (1) T-20 torque screw. It will be re-connected to harness to allow rear window functionality.

6. Remove the OEM harness from the door panel by unplugging from (3) "circled" locations and (4) press in clips in the "square" location.

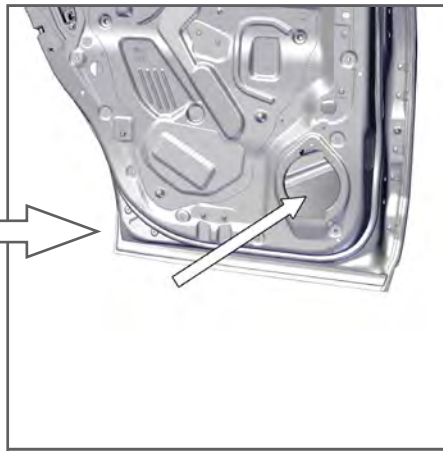

7. Attach the previously removed OEM door panel harness to the window switch and plug back into the main wiring harness.

8. Pull the wiring harness up to the door latch cable, wrap up and secure with provided foam and zip ties. The assembly should rest on top of the OEM arm rest brace. The OEM wiring harness should position inside the void area of the door panel.

ASSEMBLY DOOR PANELS

1. Position the outline of the ABS Door Panel to the shape of the OEM door frame.
2. Use (3) provided (#8 x1.0 Phillips Screws w/Washer) to attach ABS Door Panel to OEM door frame mounting points.
3. Use provided hardware (#8 Phillips Screws) to attach ABS Door Panel to door frame.

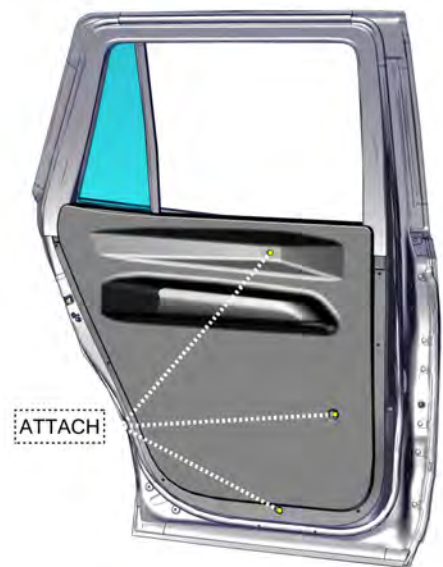

If you have questions or need further assistance please call Technical Support: 1.877.455.6886



209 W. EASY ST., ROGERS, AR 72756 • JOTTOPUBLICSAFETY.COM • 2/25

Jotto Desk™ is a patented product and Registered Trademark of Assembled Products™ Corporation.
Specifications subject to change without notice.



050-0152-00