



SINGLE CELL 2021+ DODGE DURANGO

Installation Instructions

475-2140



Note: Install Cargo Barrier first.

Part List on last page.



1 Pop plastic clips and remove Lower B Pillar Trim exposing 9/32" screw. Remove screw, then pop loose Upper B Pillar Trim from B Pillar.

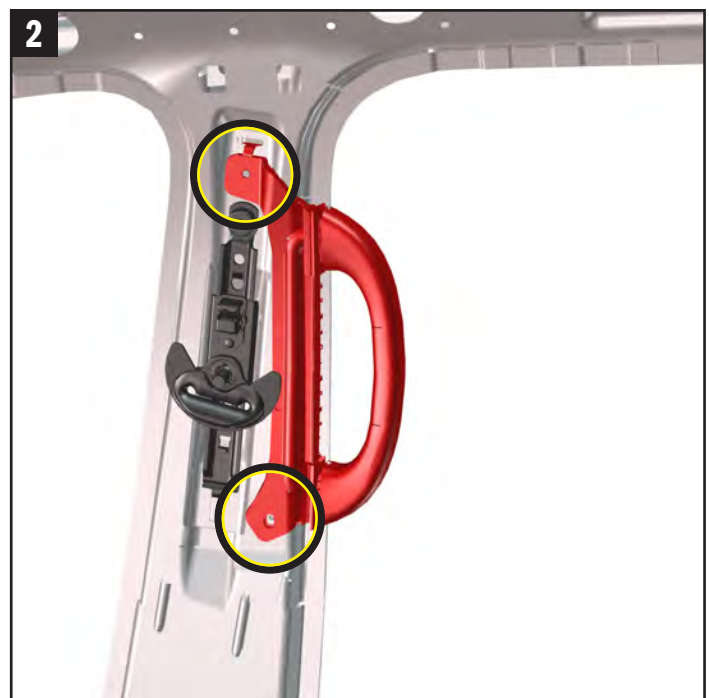

2 Use 10 mm socket to remove OEM bolts and grab handle.
Note: Grab handle not reused.

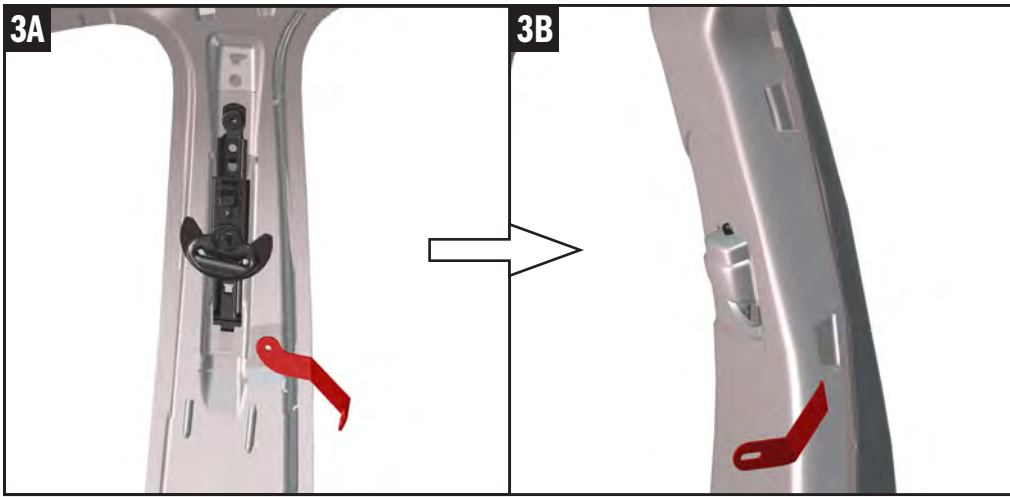

- 3** Attach the P/S B-Pillar Bracket with previously removed lower 10 mm bolt. Replace upper B-Pillar Trim and secure with previously removed 9/32" screw. Finish by snapping back into place the Lower B-Pillar Trim.
Note: Slight trimming around B-Pillar Bracket will be required.



- 4** Move seats completely forward and loosen the rear OEM 18 mm seat bolts.



- 5** Push seat up slightly to slide the Foot Mount Brackets under seat rails, between rail and rubber mat.

Note: Leave bolts loose currently.



- 6** Remove and disconnect rear controls from headliner if vehicle has them.



- 7** Detach the Rear AC Control Box from component housing. Then reconnect and position back into place.



- 8** Install Headliner HVAC Cover using the provided (4) black pan head screws.

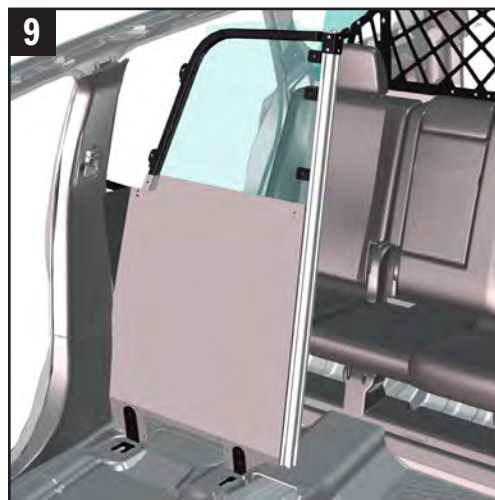

- 9** Install Assembled Front Divider into vehicle. This will require a little twisting to get into proper position. Bolt down Foot Mount Brackets to Assembled Front Divider with provided carriage bolts and flange nuts.

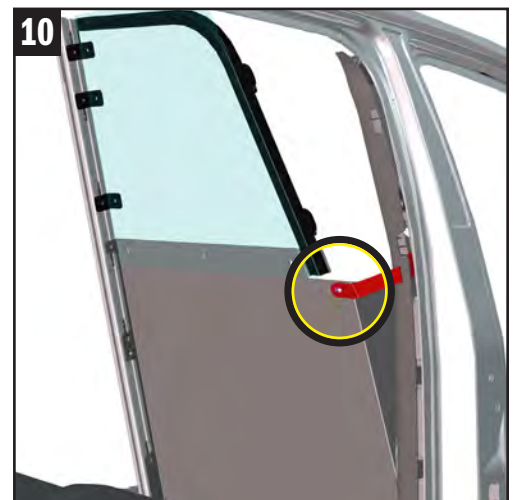

- 10** Loosely attach B Pillar Bracket onto Assembled Front Divider. Use provided carriage bolt and flange nut.

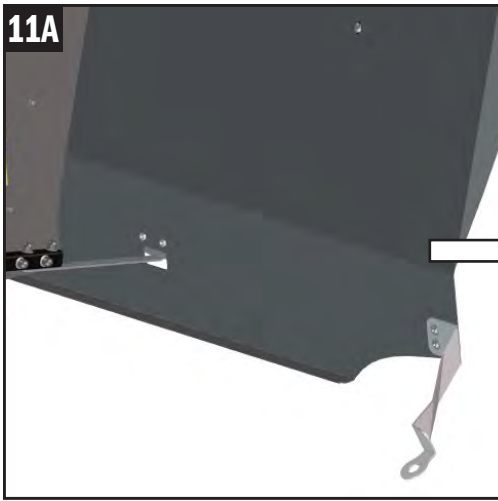

11 Fold down the D/S rear seat and secure the Lower Steel Center Divider **Bracket** to the Cargo Barrier Lower Steel Panel from cargo side with provided hardware. **NOTE: Bracket protrudes between the seat cushions.**

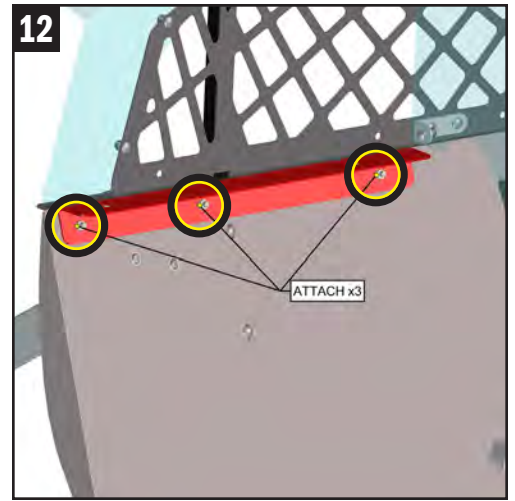
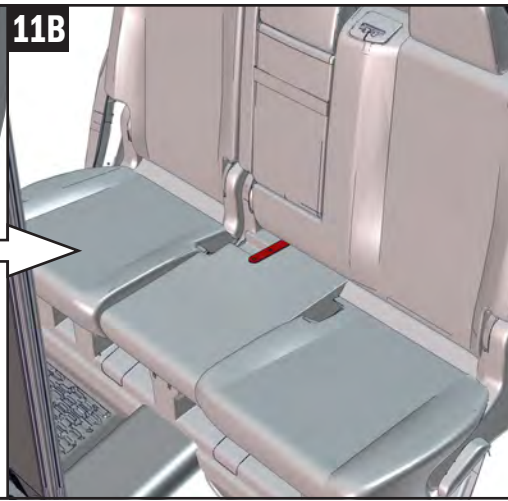

12 Fold down P/S rear seat and attach Seat Cover Bracket. Return seat to upright position.

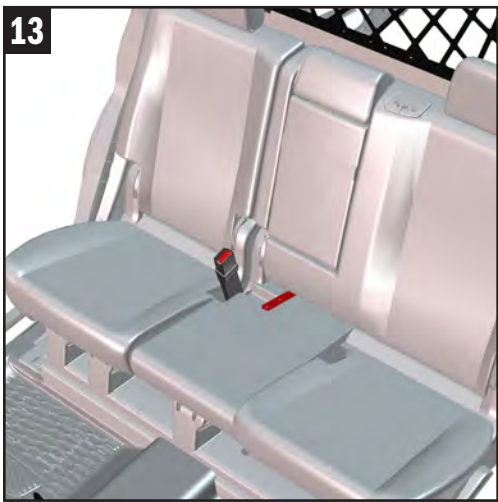

13 Fold fold D/S rear seat down and tilt forward. Remove OEM seat belt from P/S rear seat. Install Seat Belt Extender in OEM location with OEM bolt. Return D/S rear seat to upright position..

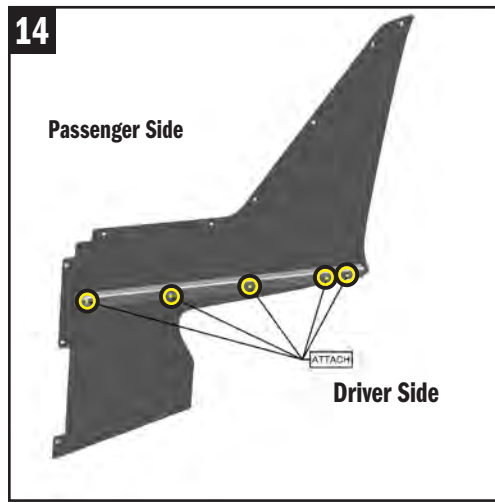

14 Outside of vehicle, attach the Lower Stiffener Tube to the D/S Lower Steel Center Divider with provided carriage bolts and flange nuts.

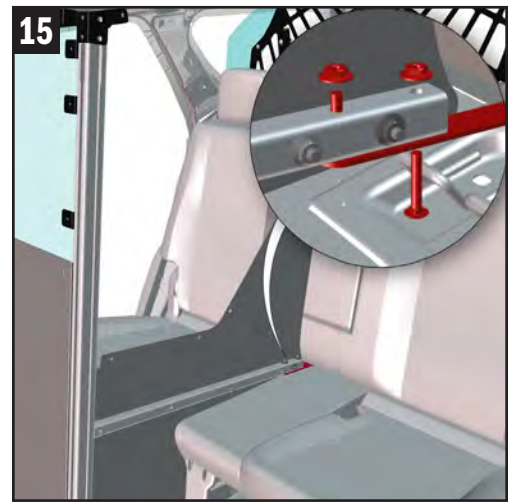

15 Install the now assembled Lower Steel Center Divider on top of the rear seat and attach the end of the Lower Stiffener Tube to the Lower Steel Center Divider Bracket with provided carriage bolts and flange nuts.

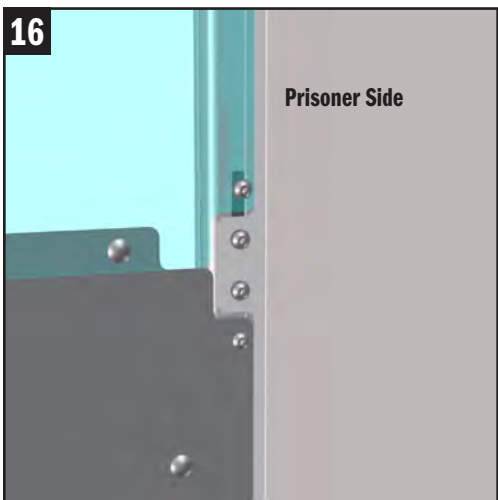

16 Loosely secure Lower Steel Center Divider onto Assembled Front Divider to the pre-positioned T-Blocks located in the rail of the Extruded Backbone with provided socket head cap screws.

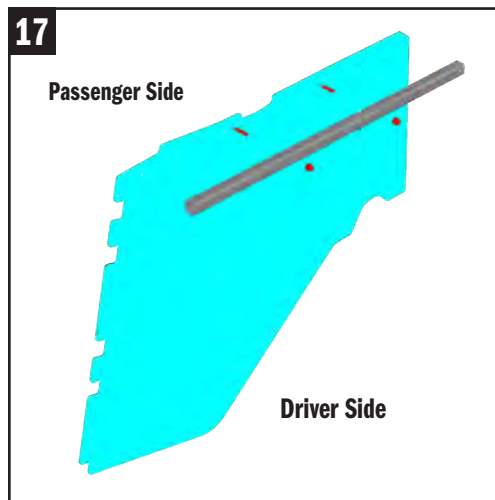

17 Outside of vehicle, attach the Stiffener Tube to the D/S Upper Poly Center Divider with provided carriage bolts and flange nuts.

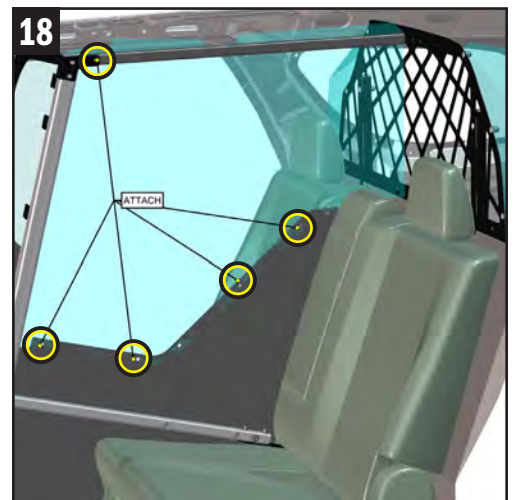

18 Attach Upper Poly Center Divider to Lower Steel Center Divider and Assembled Front Divider from P/S using provided carriage bolts and flange nuts. **Note: Loosely tighten all bolts at this time.**

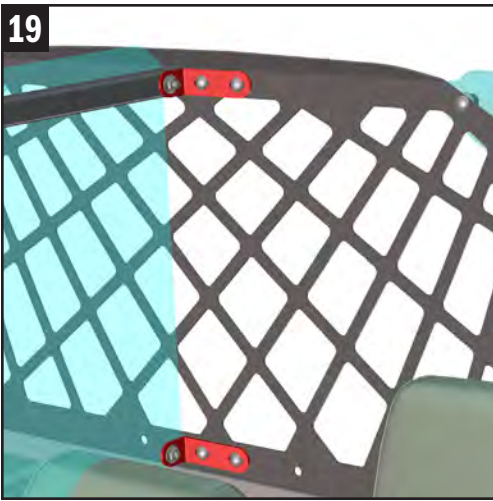

19 Attach the Secure Grid Center Divider Brackets to the Secure Grid, Stiffener Tube, and Upper Poly Center Divider with provided carriage bolts and flange nuts.

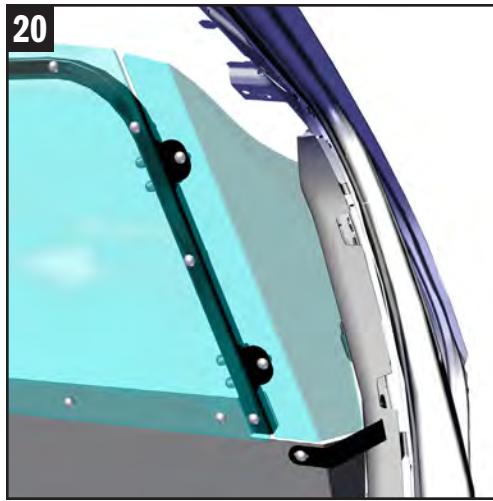

20 Install Upper Poly Wing from officer side and secure with provided carriage bolts and flange nuts.

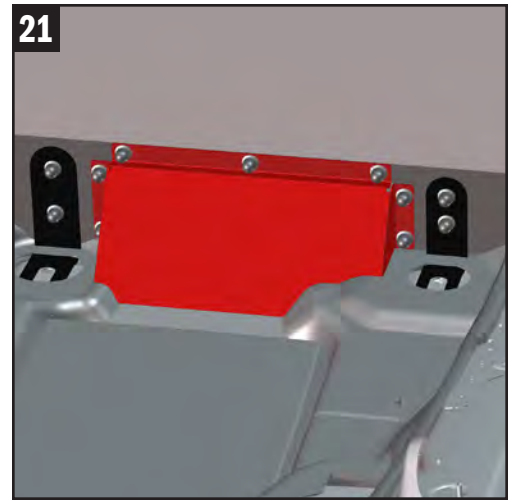

21 Secure the HSEP to the front of the Assembled Front Divider with provided carriage bolts and flange nuts.
Note: Install cap nut covers on all flange nuts.

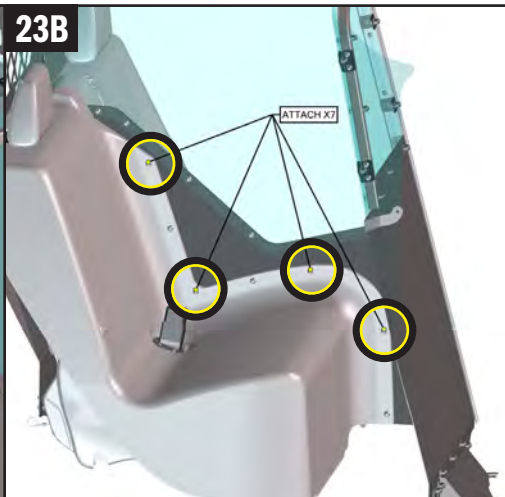
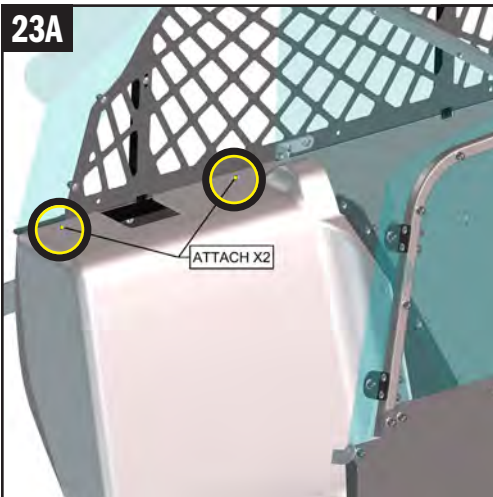

23 Secure the ABS Seat to the Cover Bracket with (2) socket head cap screws on top and (7) carriage bolts with flange nuts along the side. Be sure to pull the Seat Belt Extender through the ABS Seat

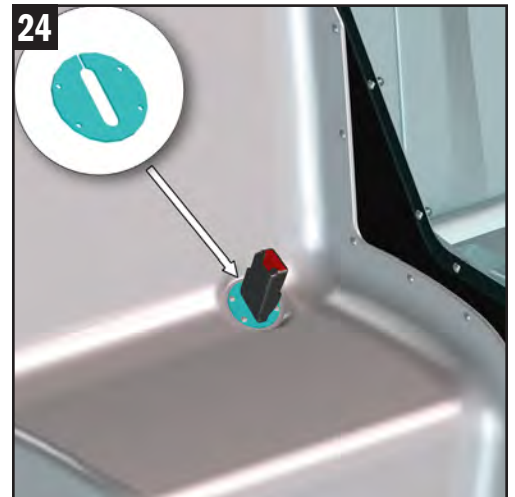

24 Secure the Seat Belt Extender to the ABS seat with the Seat Belt Retainer using provided (4) screws.

If you have questions or need further assistance please call Technical Support: 1.877.455.6886



209 W. EASY ST., ROGERS, AR 72756 • JOTTOPUBLICSAFETY.COM • 7/24

Jotto Desk™ is a patented product and Registered Trademark of Assembled Products™ Corporation.
Specifications subject to change without notice.

050-0214-00



SINGLE CELL PART LIST



Bar Style Window Armor



ABS Door Panel



Upper Poly Wing



Secure Grid Center Divider Brackets



B-Pillar Bracket



Headliner HVAC Cover



Seat Belt Extender



Seat Belt Retainer



Lower Steel Center Divider Bracket



Seat Cover Bracket



HSEP

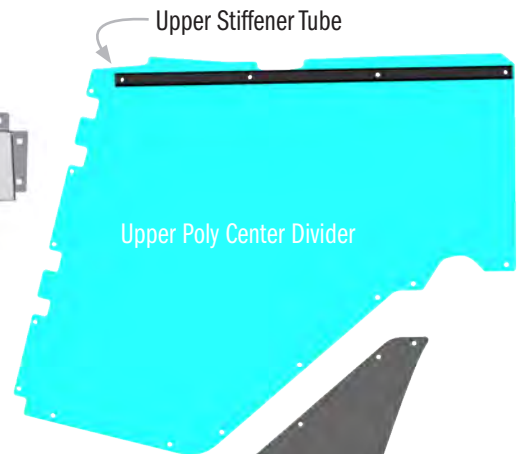

Upper Stiffener Tube

Upper Poly Center Divider



Foot Mount Brackets



Assembled Front Divider



Seat



Lower Steel Center Divider

Lower Stiffener Tube

Before beginning the installation, confirm that you have received all of the parts for your package. Read the instructions completely before starting installation.

CARGO BARRIER (CB4) PART LIST

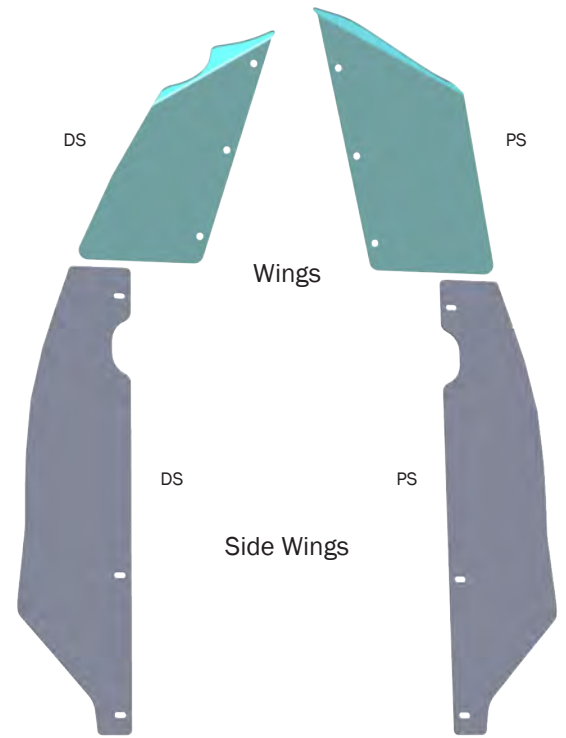
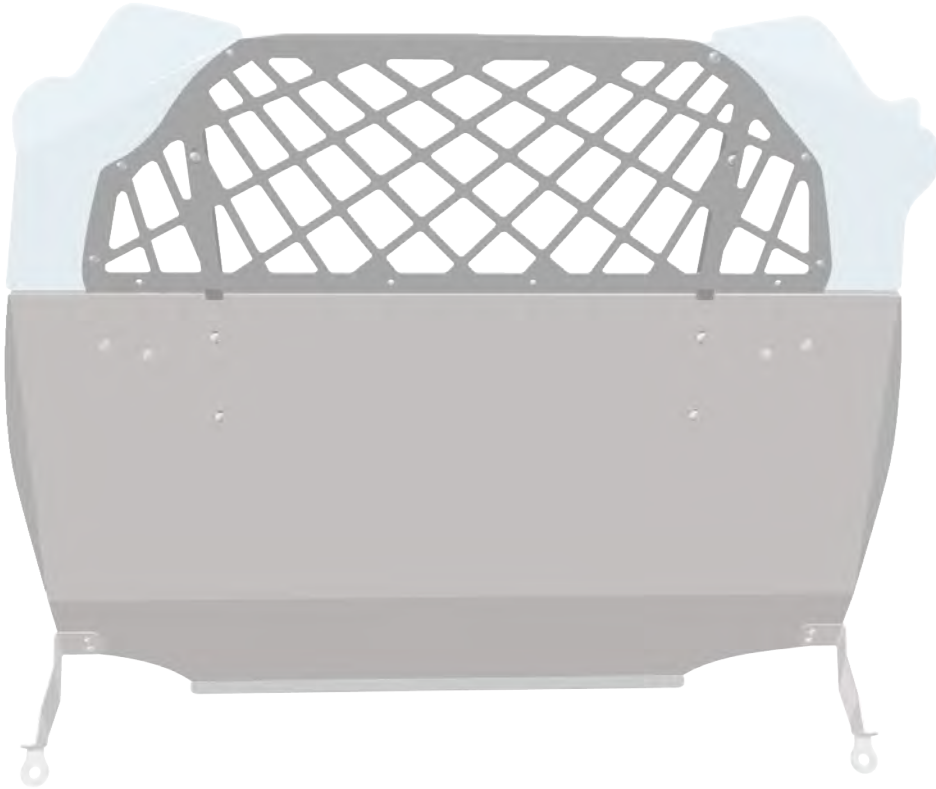

CB4 Cargo Barrier (475-1682)

Rear Mount Legs