



TM

TSP

TOTAL SOLUTIONS PROVIDER

JOTTOPUBLICSAFETY.COM

JOTTO DESK™ NO HOLES MOUNT

Field-proven over the past 20 years, the Jotto Desk offers mobile professionals the best laptop mount for cars, trucks, vans, and SUVs.

- Quick and easy installation
- Multi-point articulating arm
- Height adjustable stand
- 360° rotating laptop tray
- Ergonomically designed to reduce back strain
- Work from the driver or passenger seat
- Stores away while driving
- Easily customized



HEAVY DUTY NO HOLES MOUNT

- Upgraded HD Base
- Upgraded HD Stand
- Upgraded HD Arm



A-MOD DESKTOP

ADJUSTABLE-MOBILE
OPERATIONS DESKTOP



The A-MOD features a lightweight, rugged design. Manufactured from both high strength aluminum, composite materials where it makes sense, and steel when there is no strength substitute. It's not real security when a lock can simply be jimmied or the clamps bent and the laptop stolen. The A-MOD features a high security, solid brass, tubular lock. Side and Rear Clamps are made of case-hardened steel to keep your laptop held in place.

More A-MOD sizes and configurations available online at
jottopublicsafety.com



MOUNTING STATIONS

- Tablet mount
- Barrel key securing system

Made for:

- Apple iPad (Gen 1, 2, 3, and Pro)
- Panasonic Toughpad FZ-G1
- Microsoft Surface Pro
- HP Elite X2
- ...and more!



Works with

- Jotto Desk No Holes Mount
- Jotto Desk HD No Holes Mount

CONTOUR CONSOLES

With the development of the Jotto Desk Contour Console line in 2001, traditional console design was revolutionized. Rather than simply a box shoved between the seats and crammed with equipment, Jotto Desk evaluated the vehicle and designed consoles based upon what the vehicle would allow combined with the agencies needs. There have been many attempts to replicate our design, but none can compare.



IPBCC INTEGRATED PENTAX/BROTHER CONTOUR CONSOLE

The IPBCC design integrates the Pentax/Brother PocketJet 6/7 printer and paper roll into our newest Contour Console, providing an ergonomic setup without the twisting and turning that an armrest printer mount requires. Plus, it eliminates that additional accessory purchase and greatly improves access to a vertically mounted gun rack.

MAX DEPTH CONTOUR CONSOLE

Jotto Desk's Max Depth consoles provide extra depth where you need it most.





THE MAMBA MOUNT

Jotto Desk is upgrading and simplifying your on-duty experience with the Mamba Mount, a console side mount designed to work in each zone; Store & Drive, Park & Work, and Tactically Safe.



PARK & WORK



STORE & DRIVE



TACTICALLY SAFE

CONSOLE SIDE MOUNT

The Jotto Desk Console Side Mount (CSM) features No Holes Drilled installation on the passenger side of a compatible equipment console, preserving front passenger side leg room and improving performance. The CSM offers a straight arm which enables you to comfortably use and secure a laptop using the A-MOD or other desktop.



STANDARD CONSOLE

Standard Console are designed to mount radio, communications, siren, and light control equipment. Sloped designs allow consoles to be mounted from dash to between seats. Top-down installation using one of our floor plates and requires no drilling.

| | | |
|----------------------|--------------|-------------------|
| 12" Fire/EMS Console | 9" Console | 20" Wide Body |
| Fire/EMS Package #1 | 12" Console | 20" Wide Body IPB |
| Fire/EMS Package #2 | 15" Console | INTEGRATED |
| Fire/EMS Package #3 | 18" Lazy "L" | PENTAX/BROTHER |
| | | 20" Wide Body |
| | | AR SECURE |



FEATURING

SMARTLOCK TECHNOLOGY



ZRT GUN RACKS

The ZRT Gun Racks are designed for any configuration you can imagine. Partition Mounted, Single Cell Mounted, Rear Seat Mounted or Free Standing, and Rear Hatch Mounted – Single Weapon or Dual.

- Eliminates 12V hotwiring
- Cannot be defeated by a magnet
- Zinc lock head design deforms instead of breaking
- Silicone inserts in lock head protect weapon from damage
- Quickly adjust AR side along the strong extruded backbone to accommodate various stocks
- Single or dual weapon
- Plug and play lock head/timer wiring
- Compact size - 1/3 smaller than other lock heads
- Innovative slide latch recesses inside housing when accessing firearm

PARTITION MOUNT



SINGLE CELL MOUNT

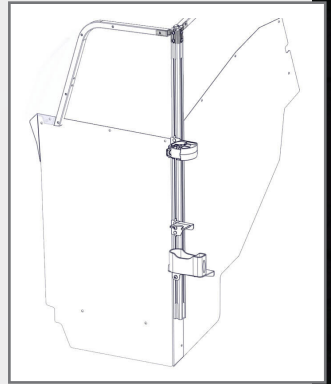

REAR HATCH MOUNT

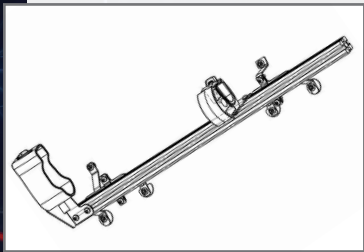

TRUNK MOUNT

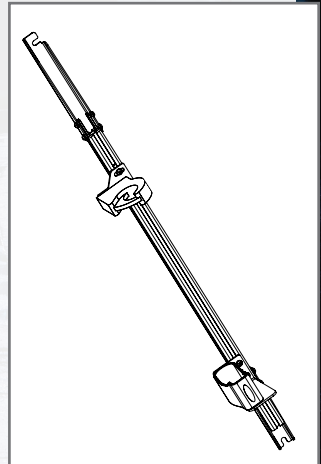

U.S. PATENT NO. 8,910,560 AND U.S. PATENT NO. 10,563,943

SPACE CREATOR VEHICLE PARTITIONS

Jotto Desk was the first to design the Space Creator Partition (US Patent No. 8,690,216), which features the Bidirectional Recessed Housing (BDRH). This innovative partition solution transforms previously unusable space to create additional leg room behind the front passenger seat. This design creates unparalleled leg room for even large prisoners while maintaining excellent use of officer seat for complete comfort. There is also plenty of room for a console, gun rack and printer.

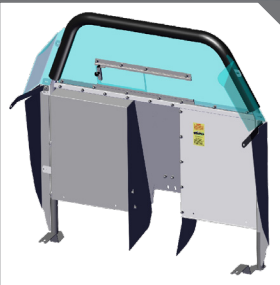

WITH HIGH SECURITY/HIGH VISIBILITY WIDOW

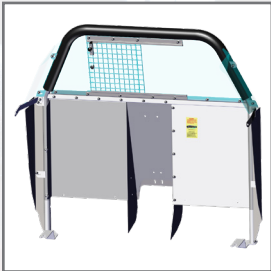

UDRH VEHICLE PARTITIONS UNIDIRECTIONAL RECESSED HOUSING

HSEP (HIGH SECURITY EXTENSION PANEL)

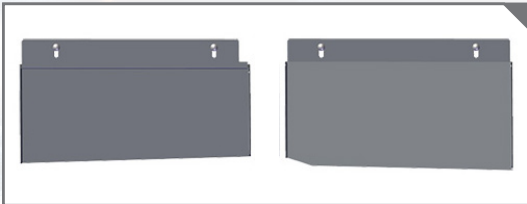

Enhance partition security by preventing rear passengers from kicking contraband under front seats with a two-piece, steel High Security Extension Panel.



REPLACEMENT BIO-SEAT SYSTEM

- Improves Officer Safety
- Immediate Upper Body Restriction
- Simple and Effective Design
- Belt Storage Position - increases ease of use
- Extremely Durable
- Quick and easy clean ups
- Efficient Installation
- Designed with OEM CAD - making contraband easy to spot and hard to hide
- Door Side Buckle System lessens prisoner contact and increased use of seat belts

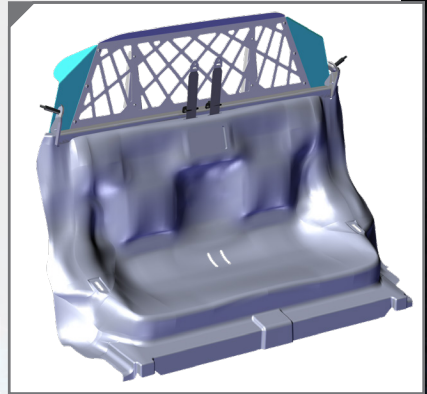

WINDOW ARMOR & DOOR PANELS

You need to protect your vehicles while transporting prisoners. Jotto Desk's line of Window Armor and Door Panels is easy to install and easy to clean. All Jotto Desk Window Armor and Door Panels are design to perfectly fit your service vehicle. Available in Secure Grid and Bar Style.



SINGLE CELL

- Creates a cocoon-like cell that allows for the complete and safe enclosure of a prisoner.
- Eliminates the prisoners ability to lie down and kick out windows or damage doors.
- Maintain 100% travel & recline ability of drivers' seat, allows taller officers to finally fit in their office.
- In a crash, the driver's seat will perform as designed by the vehicle manufacturer.
- Allows for storage behind driver seat. Keep rain gear, campaign hat, files, printer, and duty gear better stowed away.

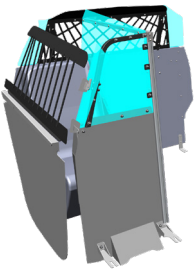

SINGLE CELL LITE



CARGO BARRIERS

Separate prisoner and rear cargo areas securely with Jotto Desk's line of Cargo Barriers. Keep prisoners in their area in case of a crash and keep cargo where it belongs. Designed to secure behind the second row of seats in a SUV, Jotto Desk Cargo Barriers utilize OEM mounting points, install quickly, and require no vehicle modifications.



CB4



CB4 with Poly Cover



DEFEND IR

You take every available precaution to secure your patrol vehicle; firearms in the gun rack, locking equipment and doors. The inconvenient truth is that the criminal element has time on their side to bypass these precautions.

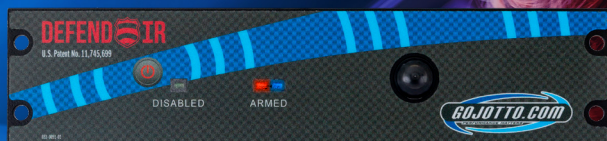

Jotto Desk is excited to introduce the Defend IR Security System. The first Security Solution against patrol vehicle break-ins. The Defend IR Monitors the interior of your vehicle utilizing an infrared sensor when armed. When a change is detected, the Defend IR activates the lights and siren of the patrol vehicle, alerting everyone nearby and scaring off a potential thief.



U.S. Patent No. 11,745,699



209 W. EASY ST., ROGERS, AR 72756 • JOTTOPUBLICSAFETY.COM • 4/24

Jotto Desk™ is a patented product and Registered Trademark of Assembled Products™ Corporation.
Specifications subject to change without notice.

